

COMMENT CRÉER UN FICHER D'IMPRESSION CORRECT - LETTRES EN CARTON

Les indications suivantes vous aideront à créer correctement un fichier d'impression.

Pour d'ultérieures informations, vous pouvez consulter la section FAQ, activer l'option Vérification fichier par un opérateur ou appeler le service assistance.

Avec ce produit, il est possible de réaliser des phrases ou des séquences de lettres en carton qui peuvent être de couleur havane (aucune impression) ou bien imprimées en quadrichromie sur fond havane (impression seulement sur le recto).

1 ORIENTATION

L'option "Orientation" se réfère au sens de lecture des caractères: dans le cas d'une orientation horizontale, on lira de gauche à droite, dans le cas d'une orientation verticale, on lira du haut vers le bas.

En fonction de l'orientation sélectionnée, nous vous fournissons un gabarit pour vous permettre d'appliquer facilement les lettres sur une éventuelle surface.

2 SET DE CARACTÈRES

Les lettres sont créées sur la base de la police **Helvetica Neue LT Std Black**. Vous trouverez ci-dessous le set des caractères disponibles.

ABCDEFGHIJKLMNOPQRSTUVWXYZ
abcdefghijklmnopqrstuvwxyz
0123456789 !?%&@€\$£

OPTION "AUCUNE IMPRESSION"

Insérez dans le champ "Champ de texte" la phrase ou la séquence de lettres que vous souhaitez commander et sélectionnez l'orientation.



OPTION "IMPRESSION SEULEMENT SUR LE RECTO"

Insérez dans le champ "Champ de texte" la phrase ou la séquence de lettres que vous souhaitez commander et sélectionnez l'orientation. Les lettres en carton peuvent être imprimées seulement sur un côté avec un pattern continu que vous pouvez créer en suivant les indications ci-après.



3 FORMAT DU FICHER

Veillez envoyer votre fichier au format **PDF à l'échelle 1:1 (non protégé par mot de passe)**.

4 COULEURS

Veillez noter que dans le produit imprimé, **les couleurs seront plus foncées car le support d'impression est de couleur havane** et non pas blanc papier. De plus, les éléments que vous voyez en blanc dans votre fichier seront transparents sur le produit imprimé. Tous les fichiers doivent être envoyés en **CMJN** (cyan, magenta, jaune noir) avec le profil **colorimétrique Fogra 39**. Les images en RVB ou avec couleurs PANTONE seront automatiquement converties avec un profil de séparation standard.

5 RÉOLUTION

La résolution optimale des fichiers pour l'impression est **comprise entre 100 et 150 dpi**.

6 INFORMATIONS SUPPLÉMENTAIRES

La taille du trait minimum imprimable est de 0,5 pt.

7 PATTERN PERSONNALISÉ

Le pattern personnalisé devra avoir les dimensions 35x35 cm dans le cas de lettres d'une hauteur moyenne de 25 cm et 70x70 cm dans le cas de lettres d'une hauteur moyenne de 50 cm.

Veillez télécharger sur notre site **le gabarit et utilisez-le comme base pour positionner votre graphisme**: vous y trouverez déjà les dimensions du pattern correctement mises en place. **Il est fondamental que les éléments graphiques qui composent votre pattern soient disposés de manière à pouvoir être multipliés en séquence sans interruptions.** Pour finir, enregistrez le fichier en pdf sans insérer de fond perdu, repères ou traits de coupe.

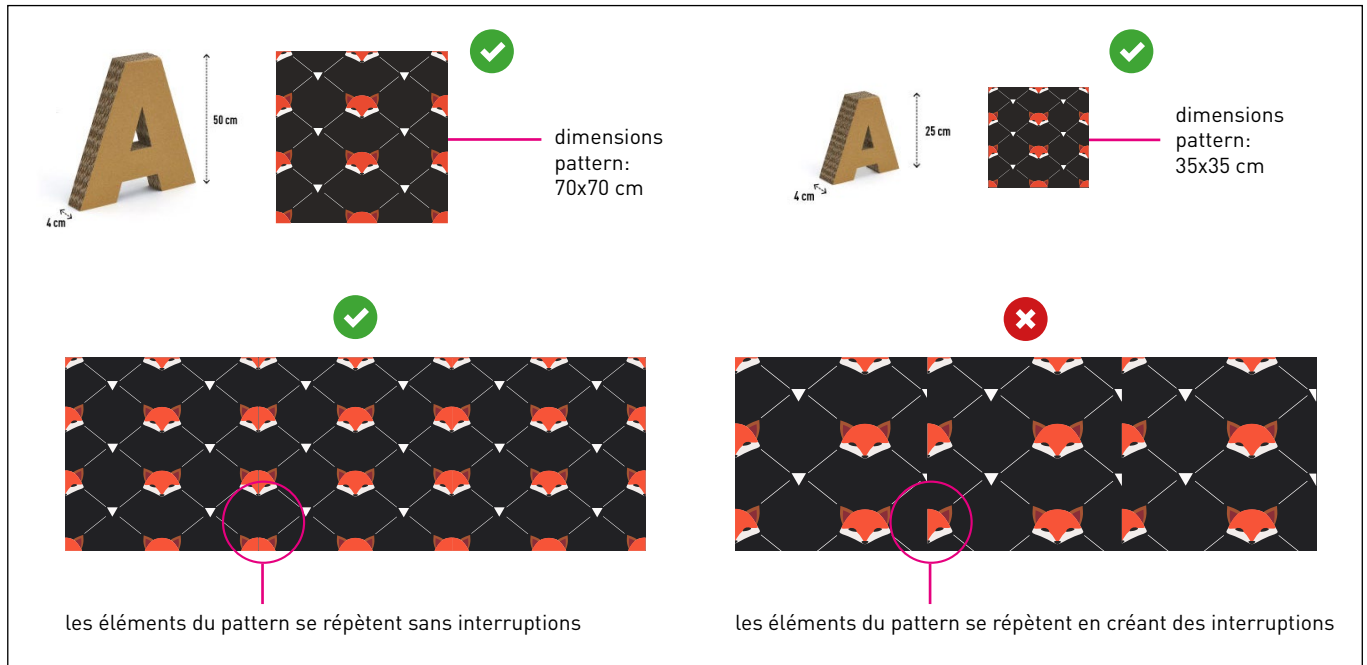

NOTA BENE - Lettres en carton imprimées

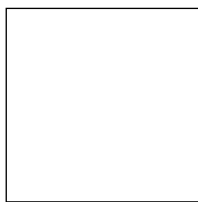

TÉLÉCHARGEZ
LE GABARIT

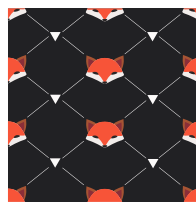

INSÉREZ VOTRE
PATTERN



ENREGISTREZ
LE PDF



PDF



100-150 dpi



CMJN



FOGRA 39



fond perdu



traits de coupe

Orientation horizontale

WoW



Orientation verticale

**W
o
W**



Les couleurs sont plus foncées par rapport à votre fichier car le support d'impression est de couleur havane. De plus, les éléments que vous voyez en blanc dans votre fichier seront transparents sur le produit imprimé.

LETTRES de 25 cm de hauteur

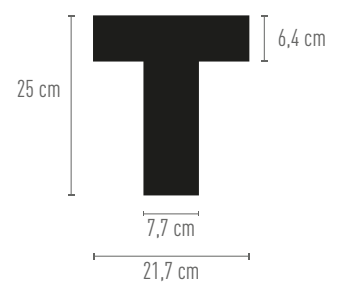
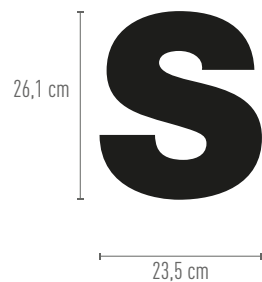
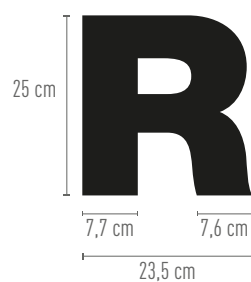
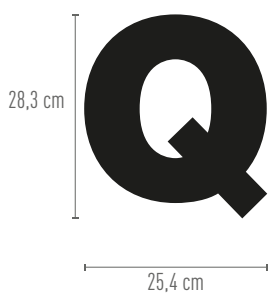
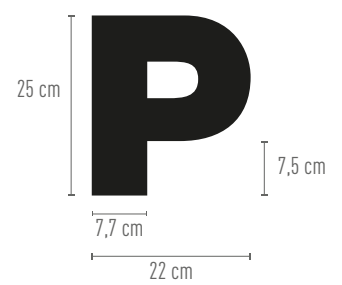
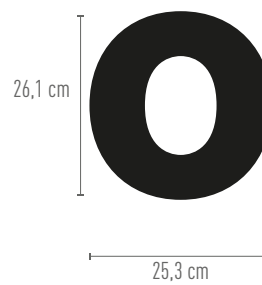
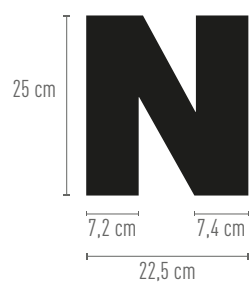
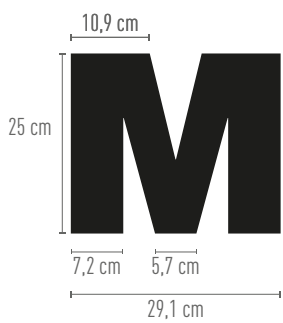
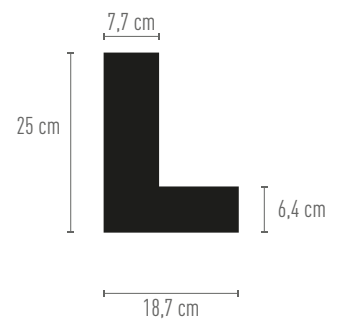
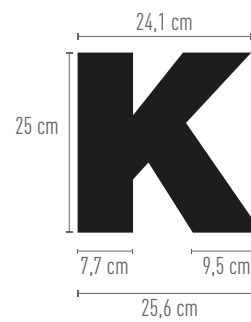
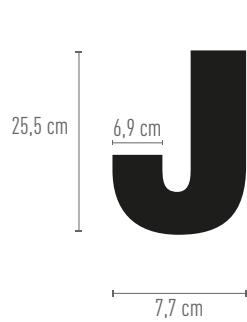
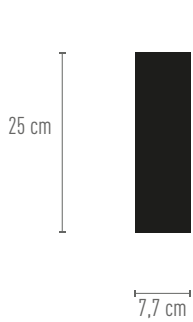
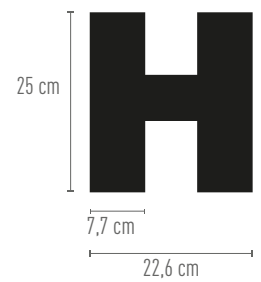
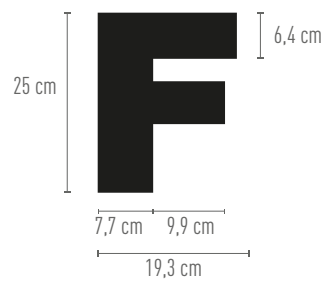
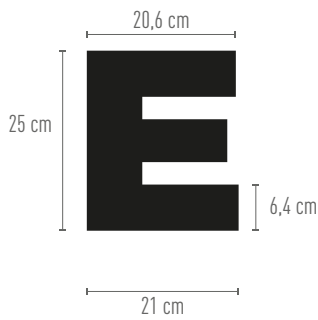
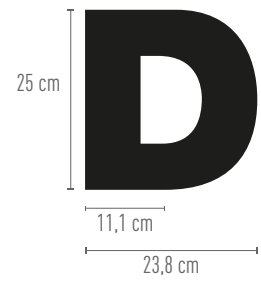
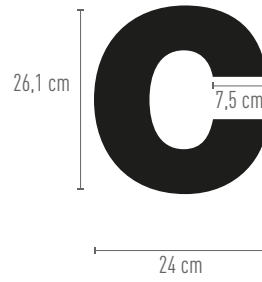
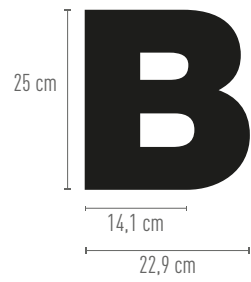
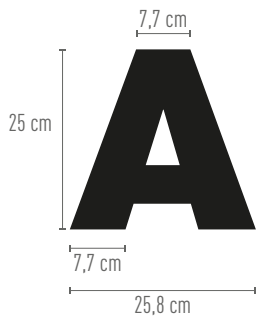

LETTRES de 25 cm de hauteur

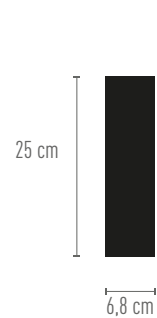
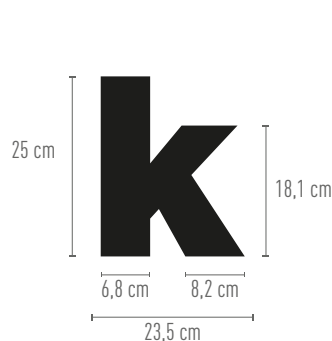
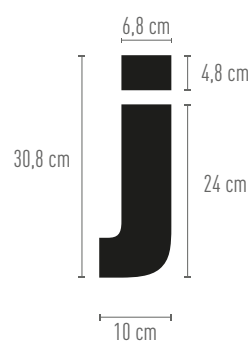
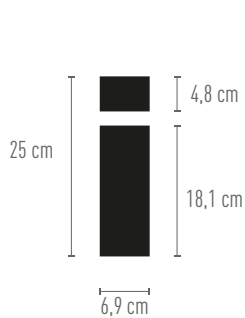
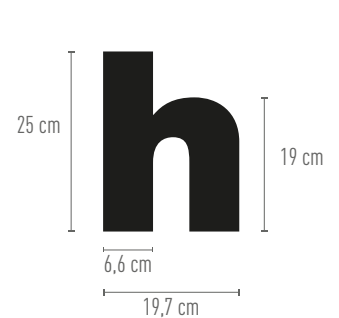
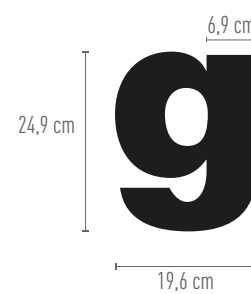
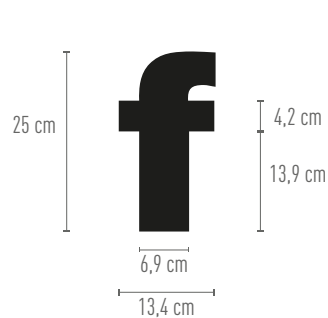
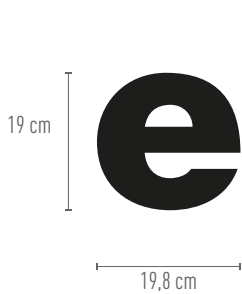
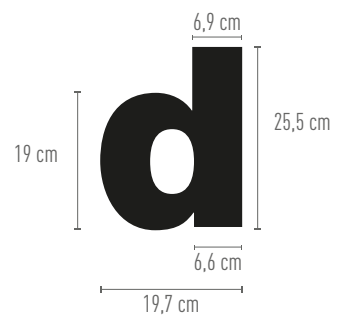
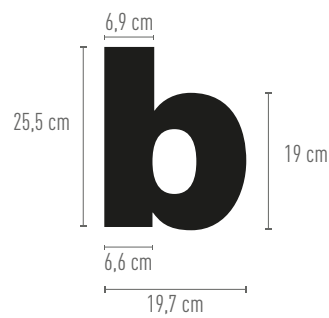
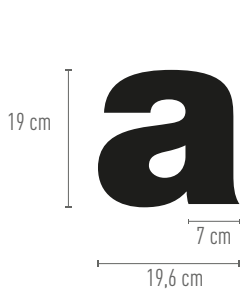
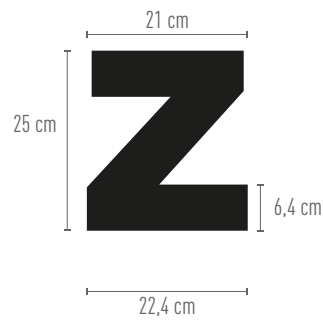
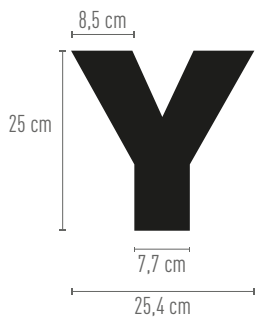
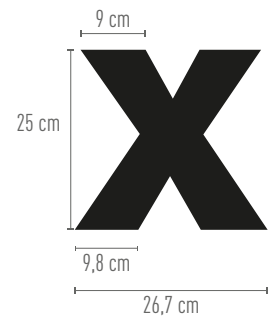
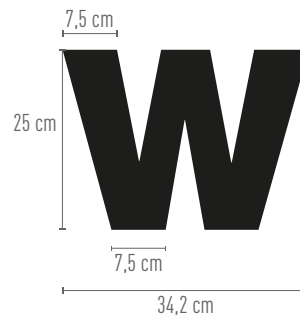
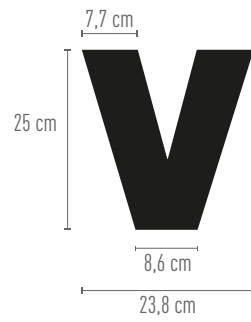

LETTRES de 25 cm de hauteur

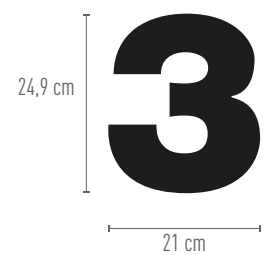
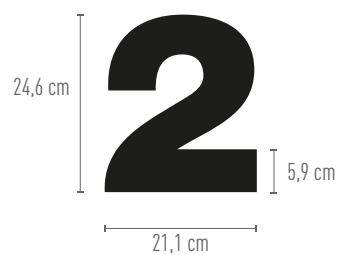
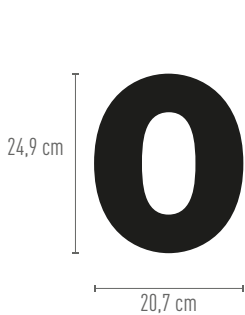
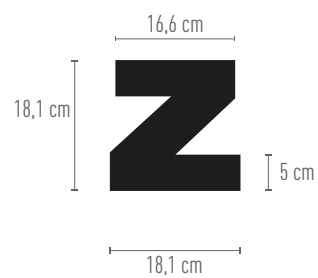
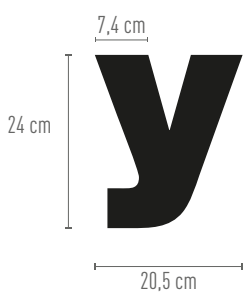
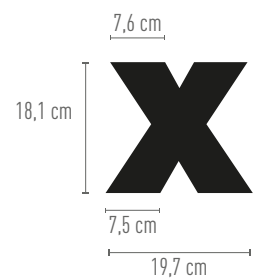
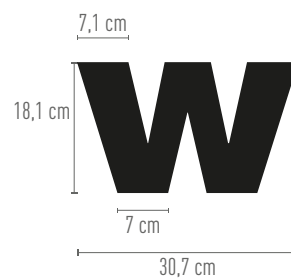
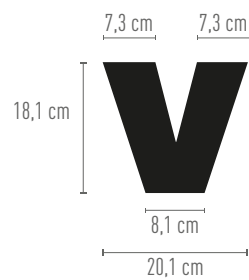
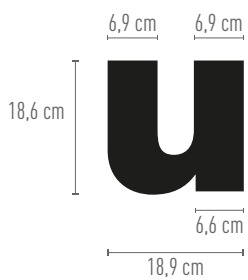
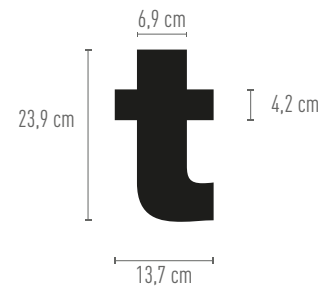
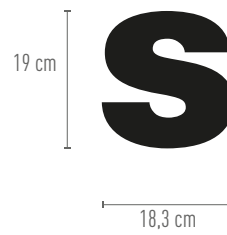
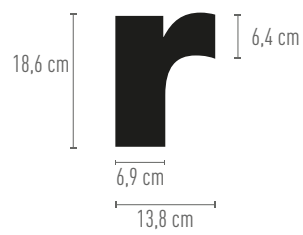
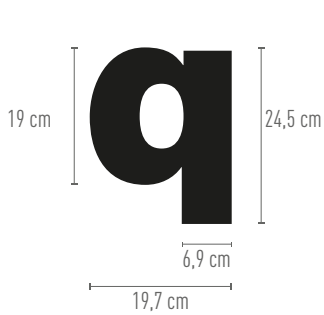
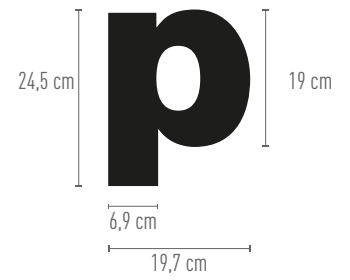
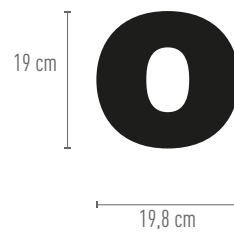
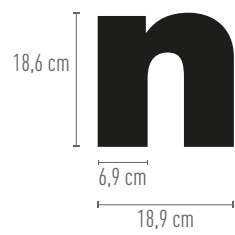
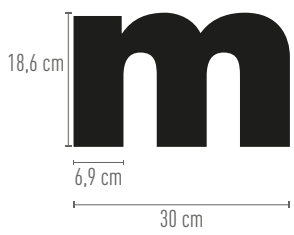

LETTRES de 25 cm de hauteur

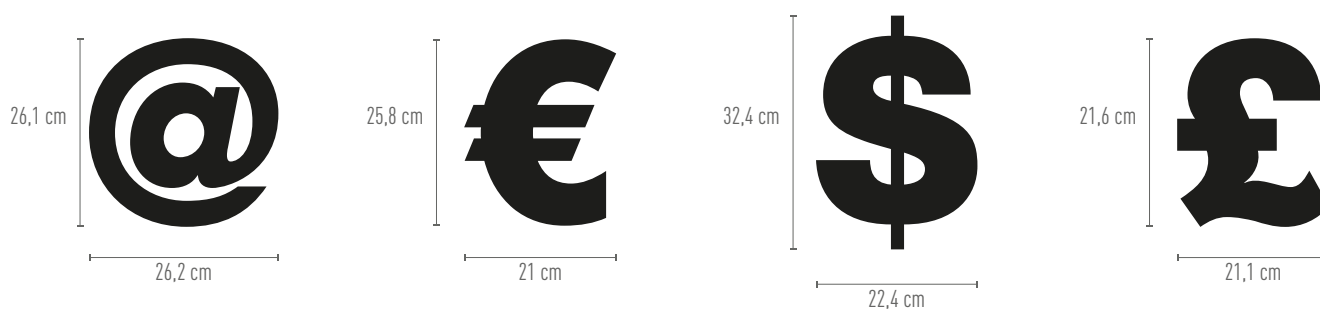
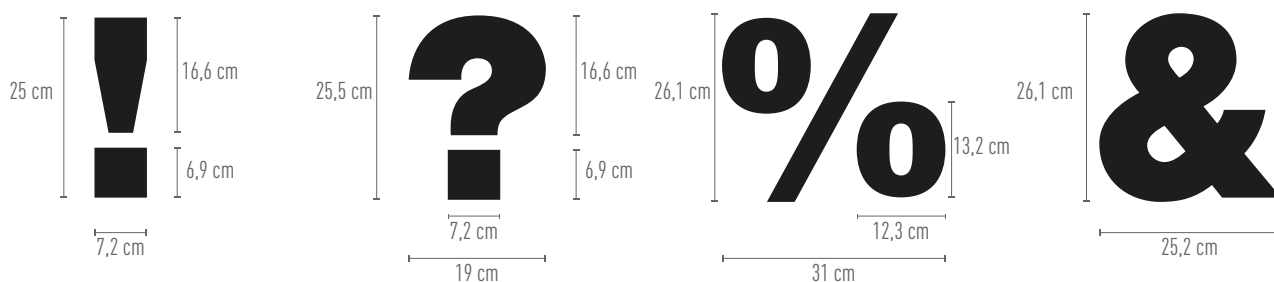
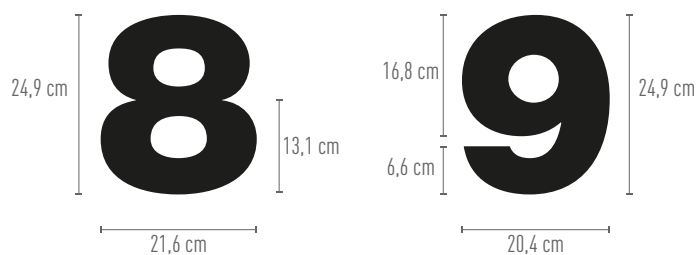
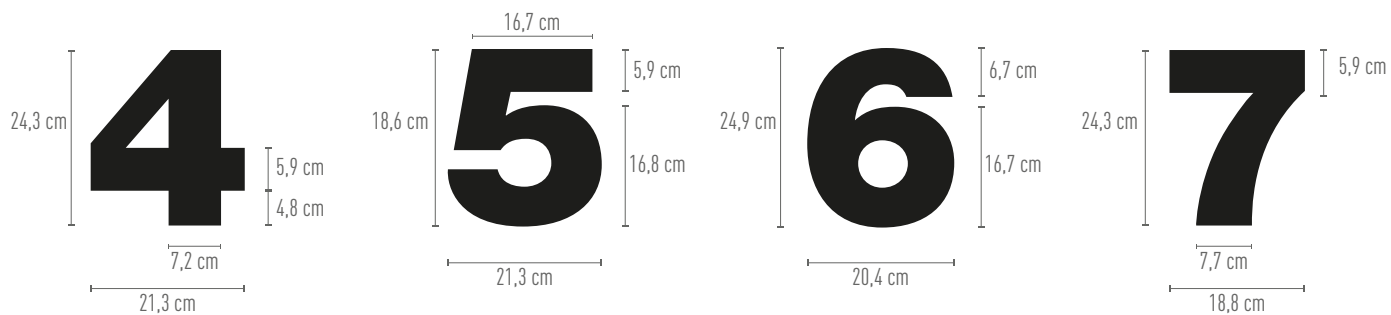

LETTRES de 50 cm de hauteur

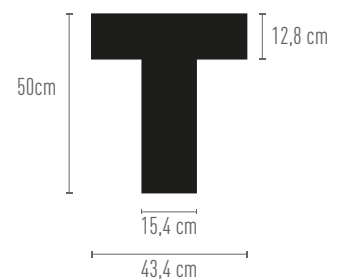
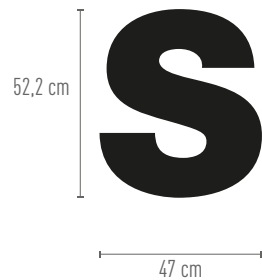
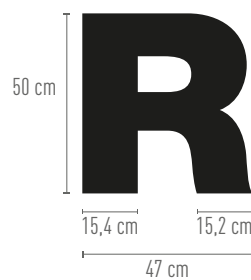
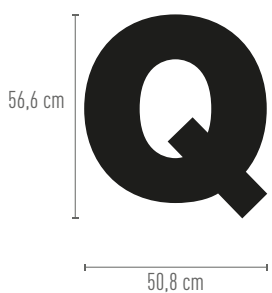
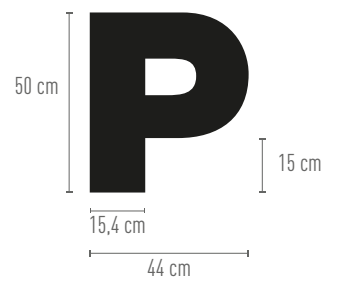
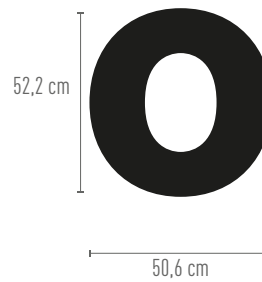
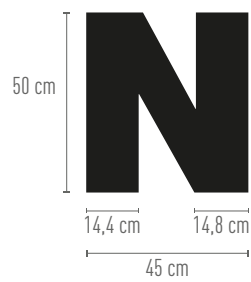
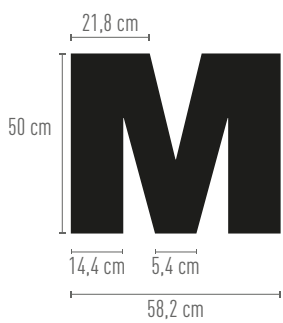
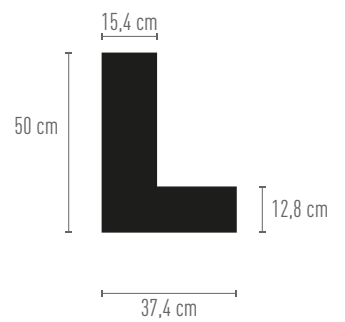
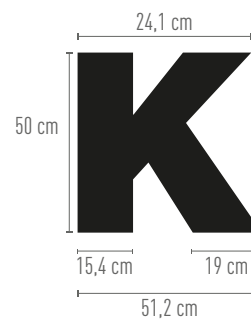
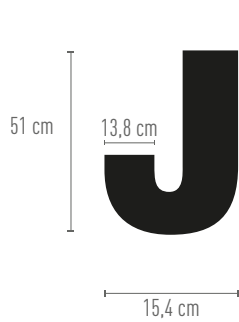
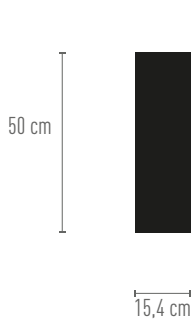
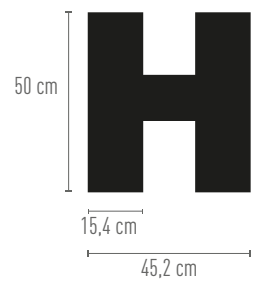
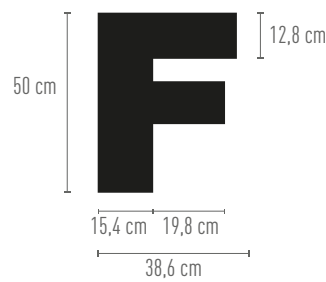
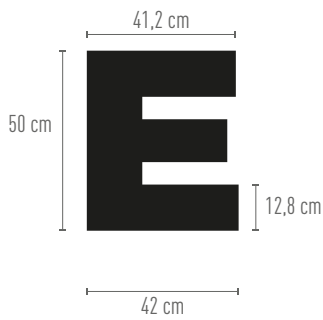
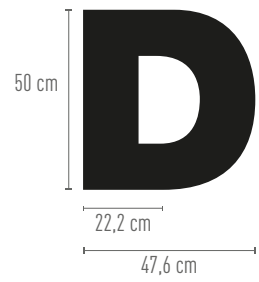
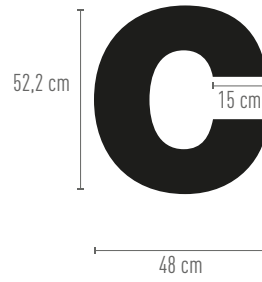
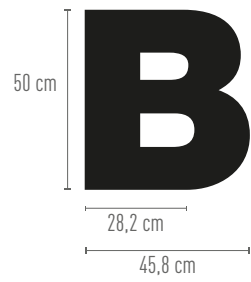
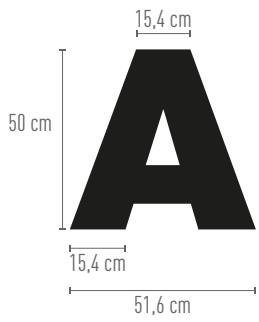

LETTRES de 50 cm de hauteur

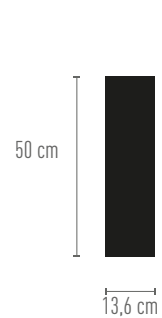
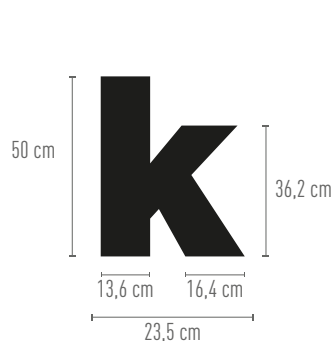
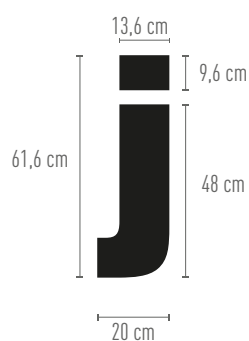
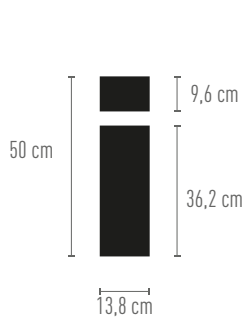
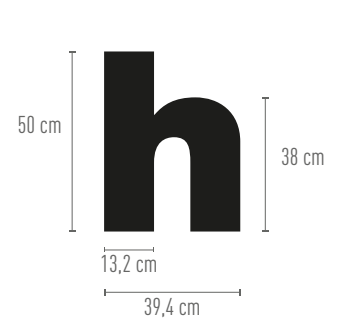
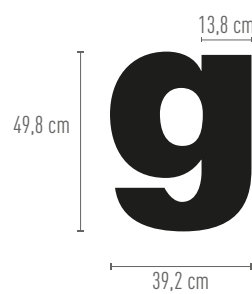
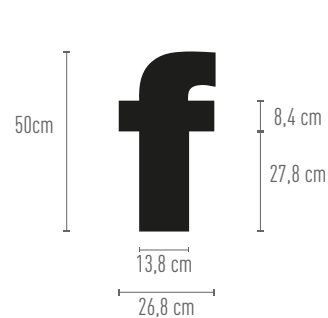
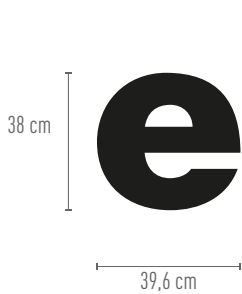
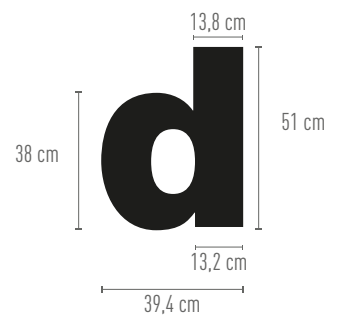
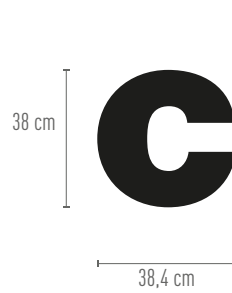
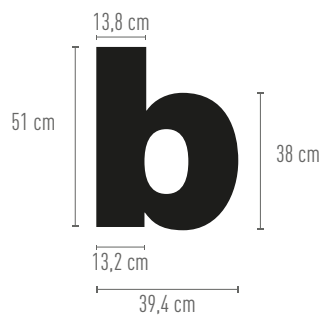
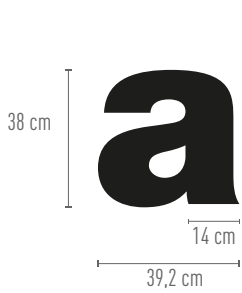
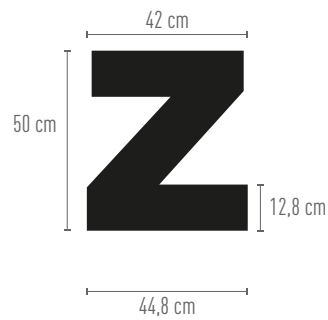
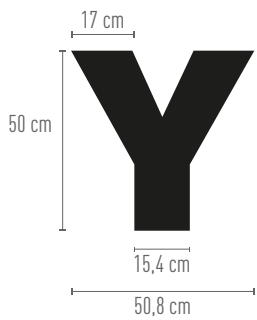
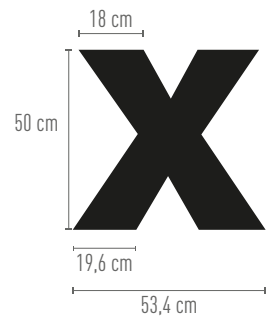
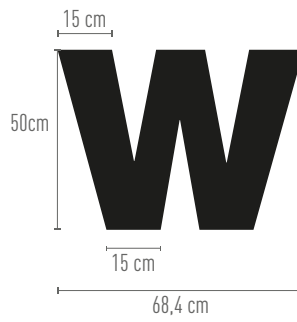
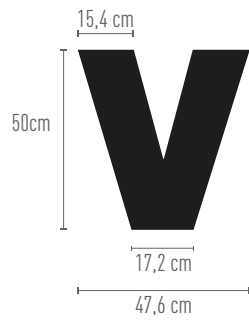
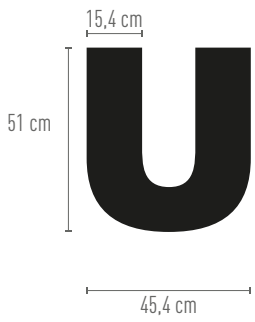

LETTRES de 50 cm de hauteur

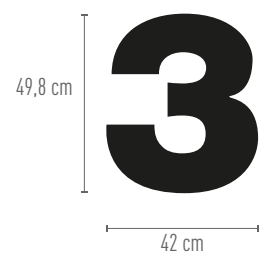
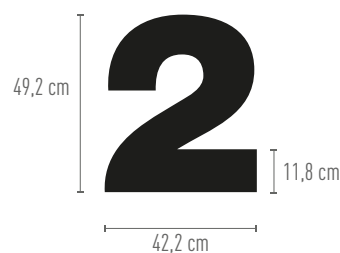
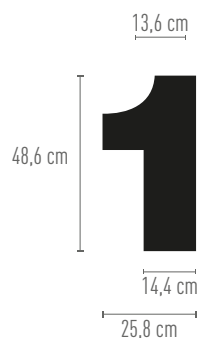
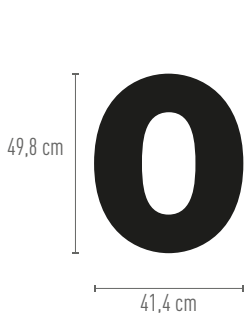
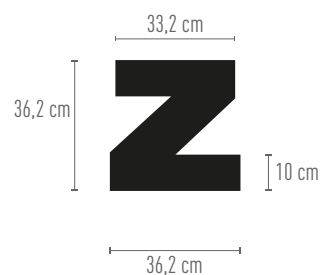
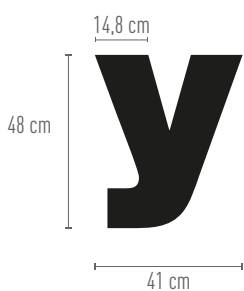
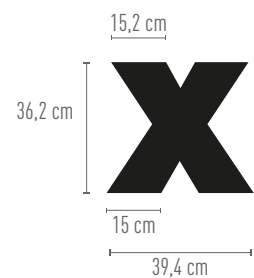
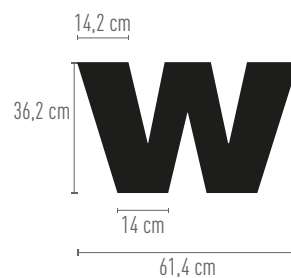
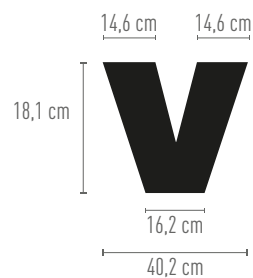
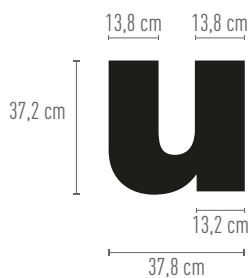
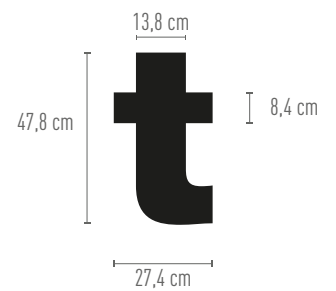
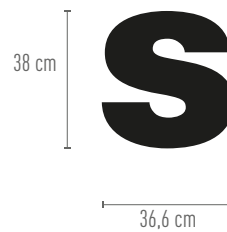
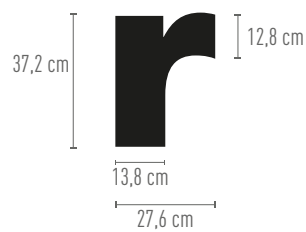
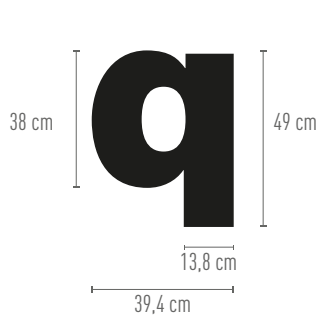
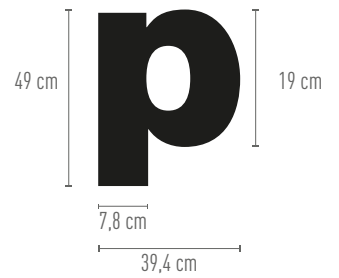
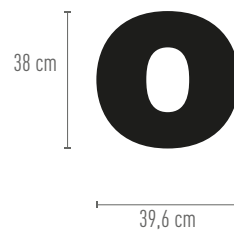
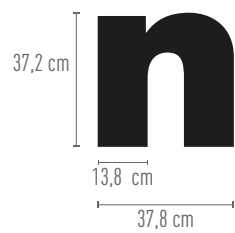
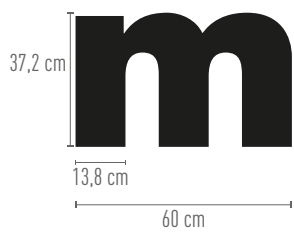

LETTRES de 50 cm de hauteur

